

Detail A

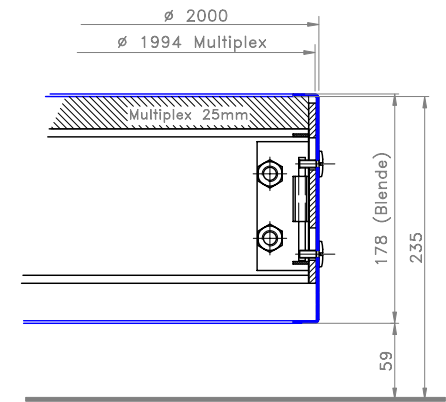

Detail A M 1:1

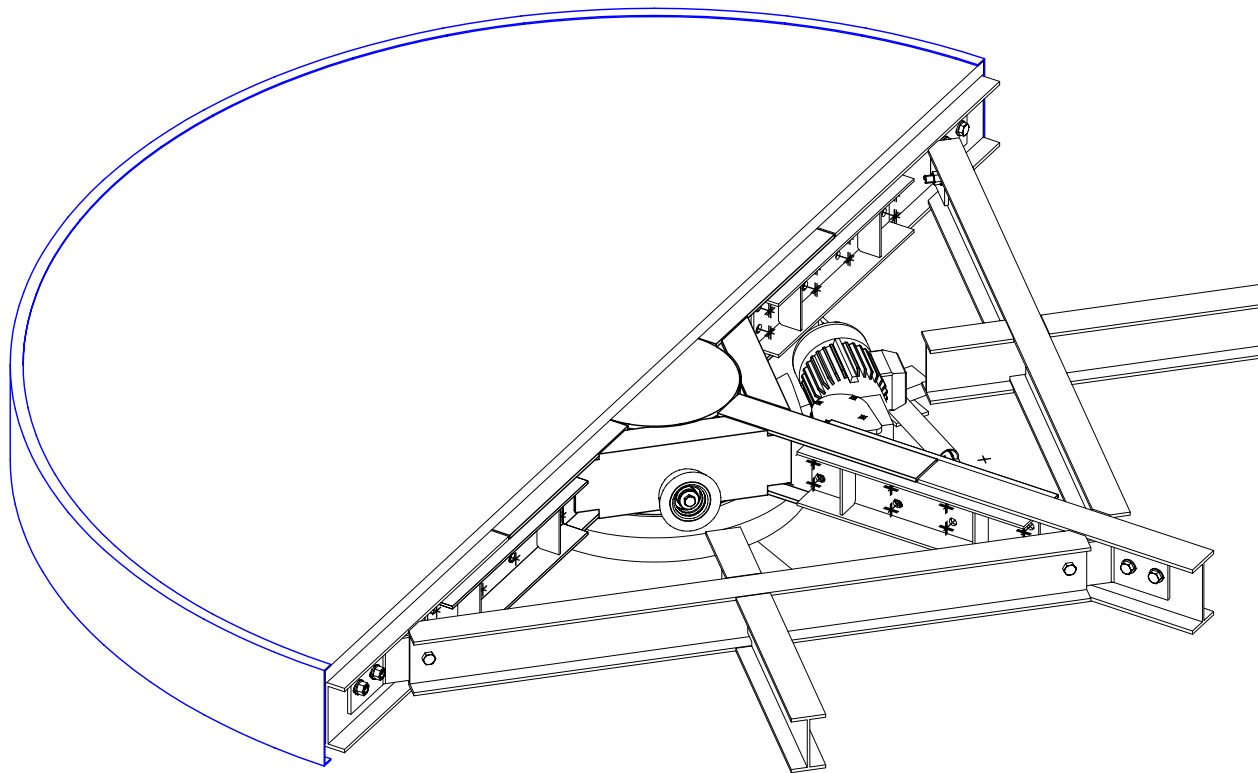

Drehscheibe Typ DSK 20/05

Bumat Bewegungssysteme GmbH
 Pfälzer Ring 30
 D-68766 Hockenheim

Tel.: +49 (0) 6205.9413-30
 Fax: +49 (0) 6205.9413-55
 info@bumat.com
 www.bumat.com

