

Inkl. Randblende

∅13000

∅12994 (Multiplex)

Blende
höhenverstellbar

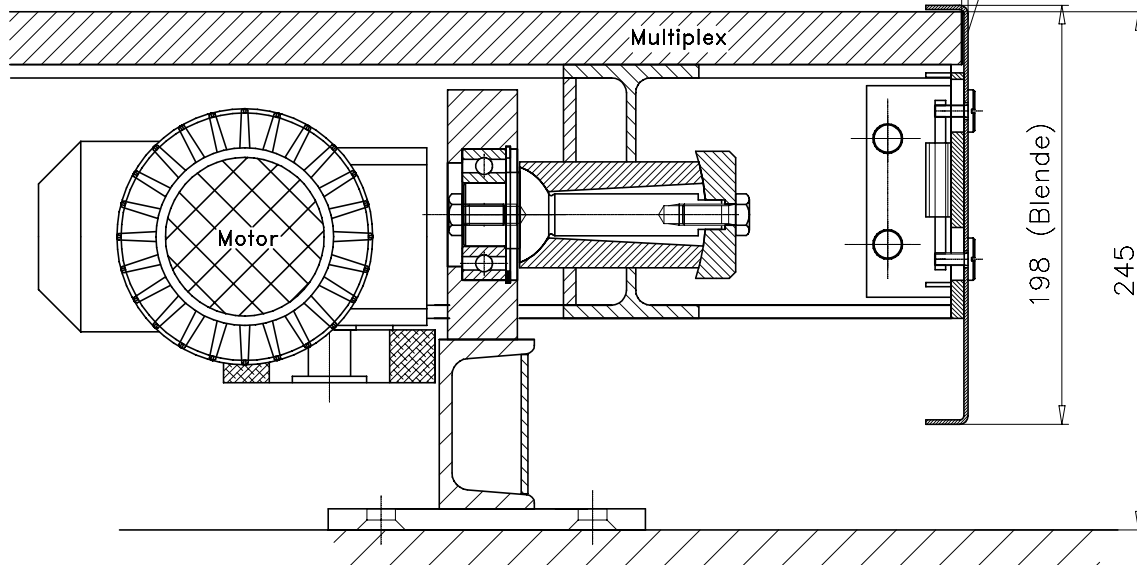

ohne Randblende

∅12994 (Multiplex)

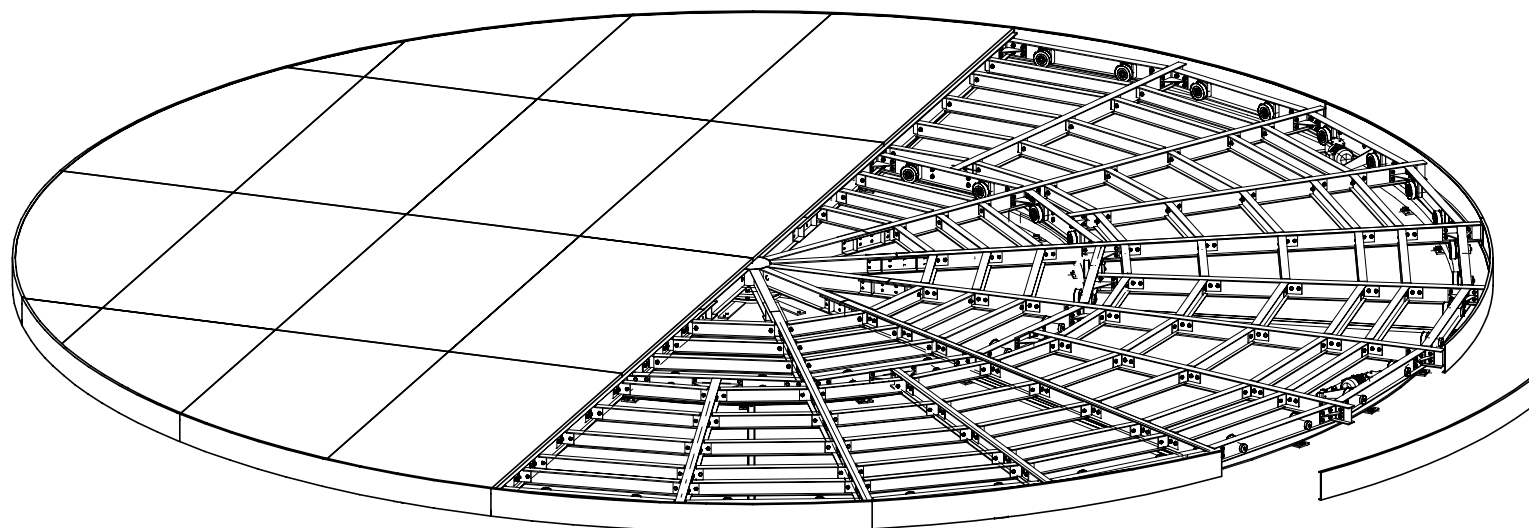
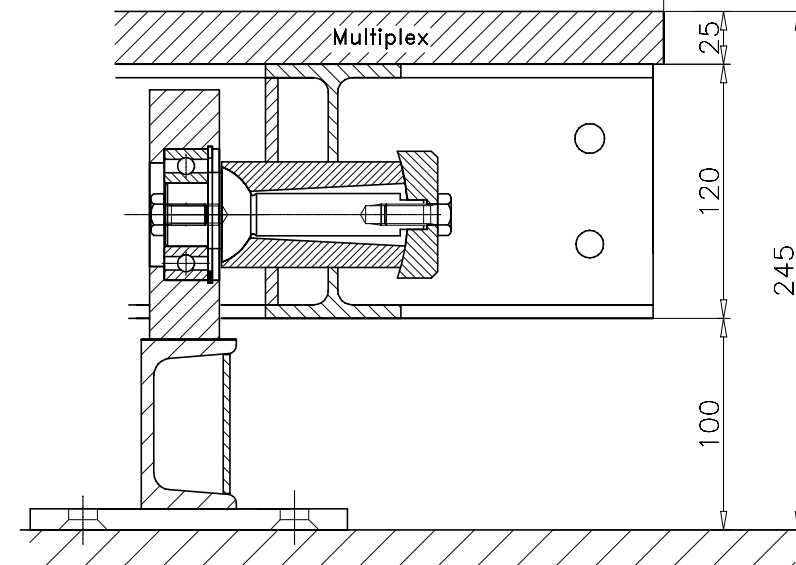

Drehscheibe Typ DSMA 130/120/95/45-24

Bumat Bewegungssysteme GmbH
Pfälzer Ring 30
D-68766 Hockenheim

Tel.: +49 (0) 6205.9413-30
Fax: +49 (0) 6205.9413-55
info@bumat.com
www.bumat.com

