

Inkl. Randblende

Ø6500

Ø6494 (Multiplex)

Blende
höhenverstellbar

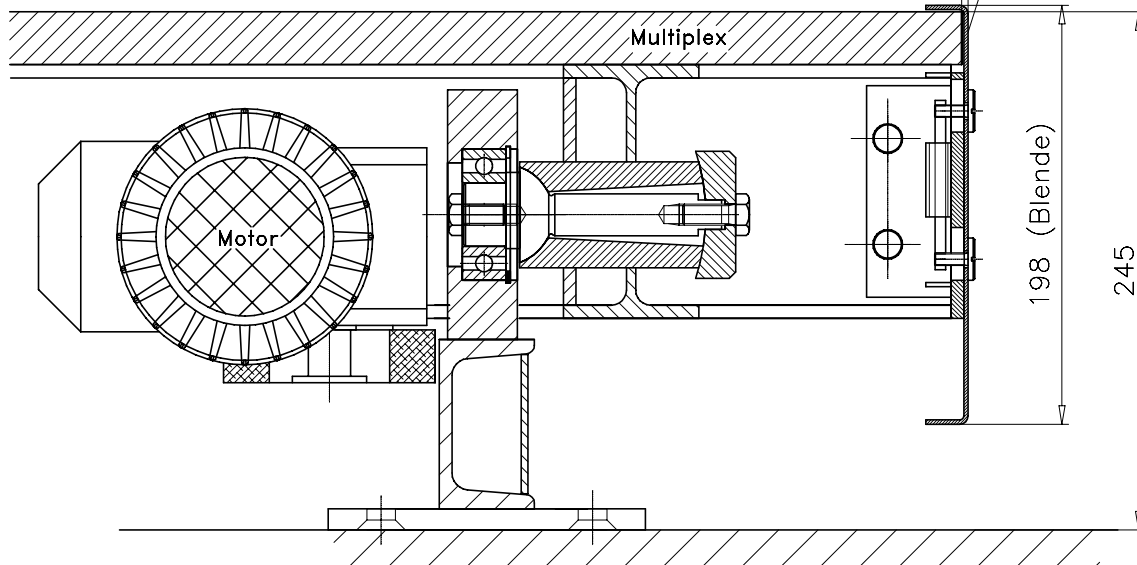

ohne Randblende

Ø6494 (Multiplex)

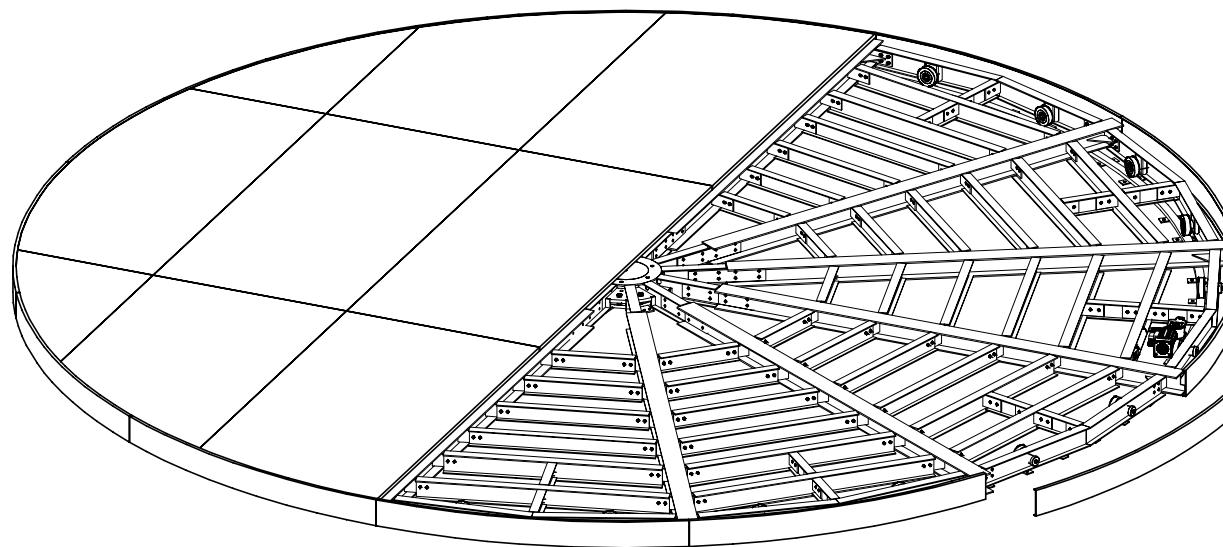
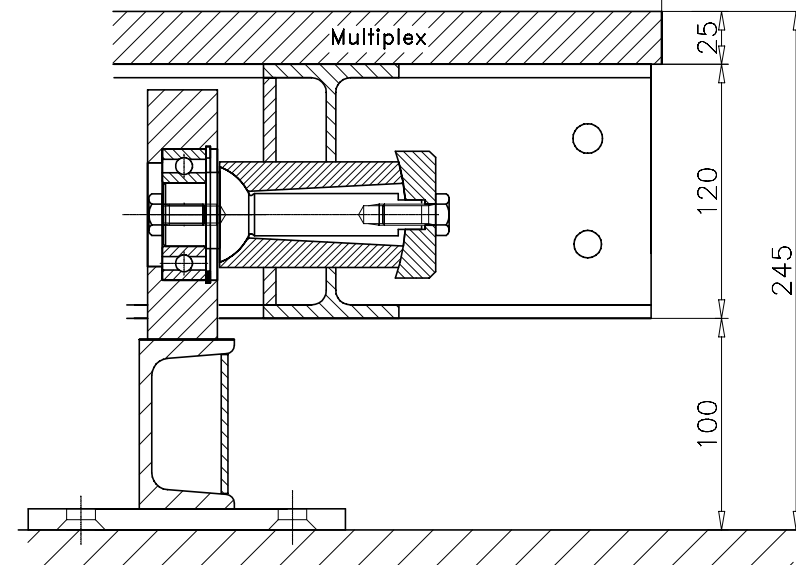

Drehscheibe Typ DSMA 65/60-12

Bumat Bewegungssysteme GmbH
Pfälzer Ring 30
D-68766 Hockenheim

Tel.: +49 (0) 6205.9413-30
Fax: +49 (0) 6205.9413-55
info@bumat.com
www.bumat.com

