

with facing strip

ø5000

ø4994 (multiplex)

height-adjustable skirt

multiplex

Motor

198 (skirt)

245

without facing strip

ø4994 (multiplex)

multiplex

25

120

100

245

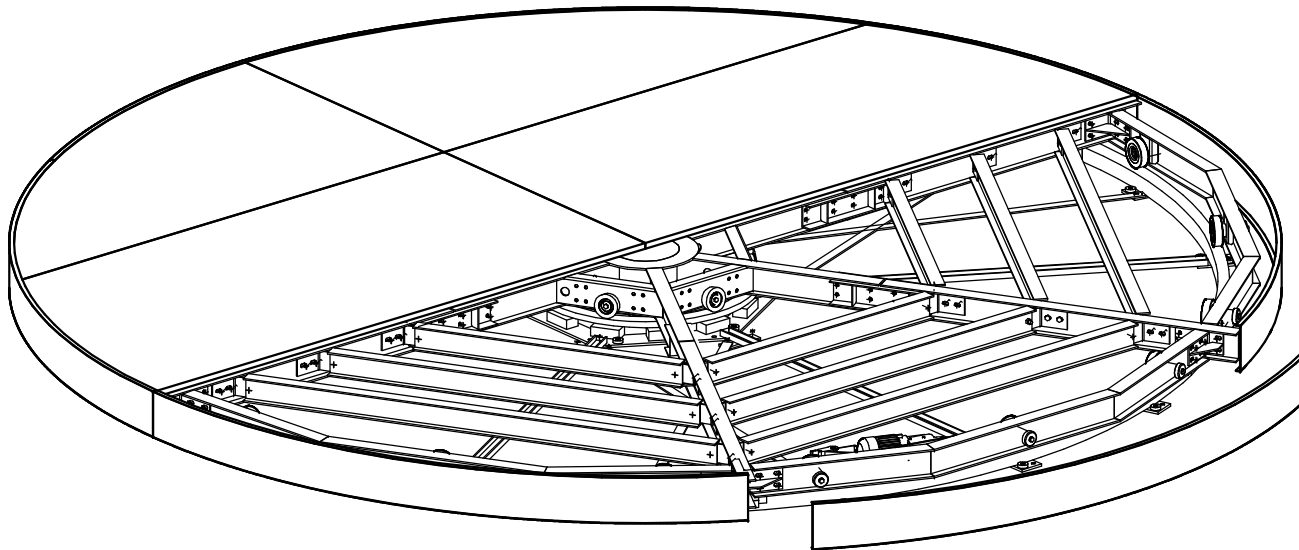

turntable model DSMA 50/45-6

Bumat Bewegungssysteme GmbH
Pfälzer Ring 30
D-68766 Hockenheim

Tel.: +49 (0) 6205.9413-30
Fax: +49 (0) 6205.9413-55
info@bumat.com
www.bumat.com

