

avec cache périphérique

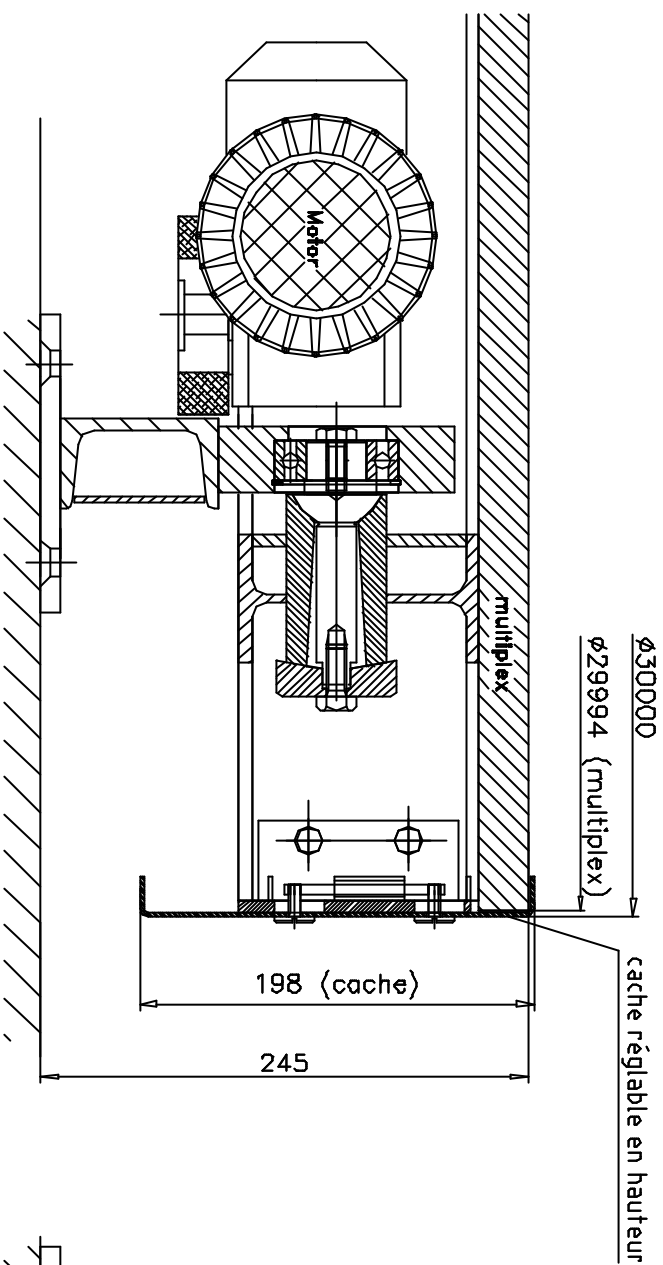

sans cache périphérique

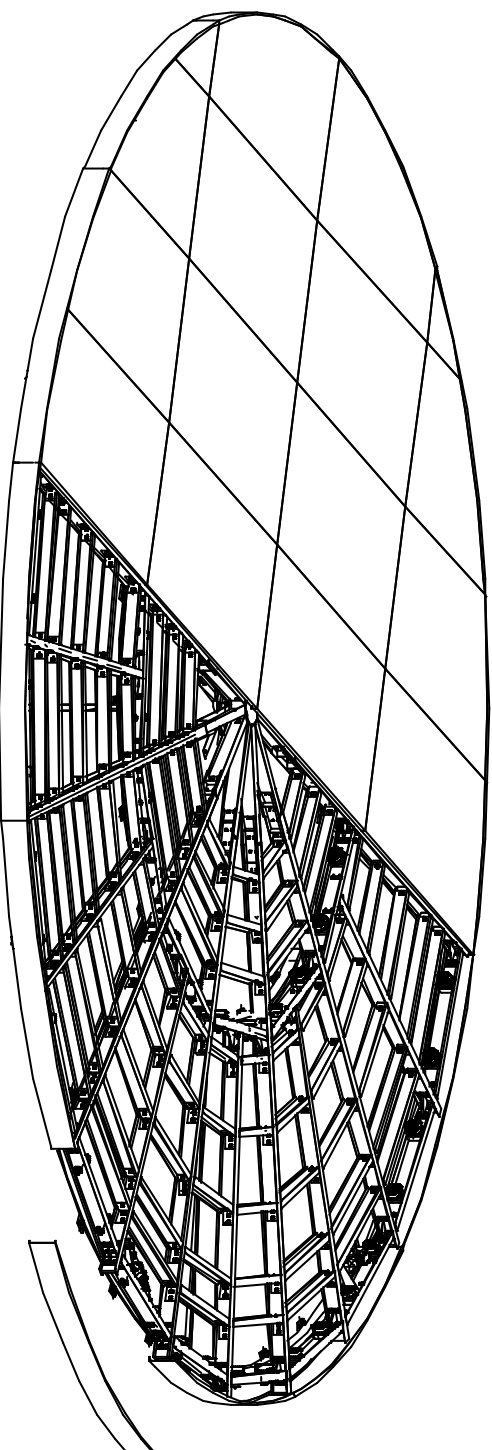
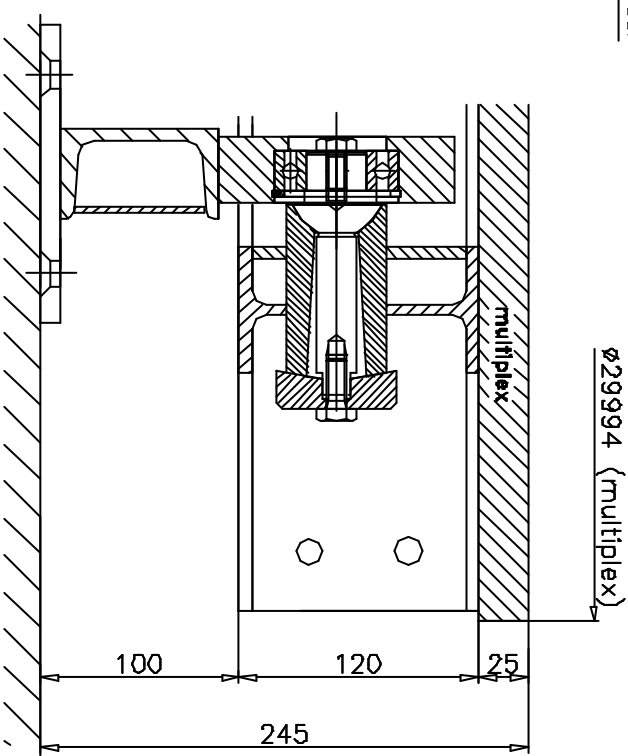

Plateau tournant DSMA 300/295...95/45-48

Burnet Bewegungssysteme GmbH
Pflüzer Ring 30
D-66786 Hockenheim

Tel.: +49 (0) 6206 9413-30
Fax: +49 (0) 6206 9413-55
info@burnet.com
www.burnet.com

