

avec cache périphérique

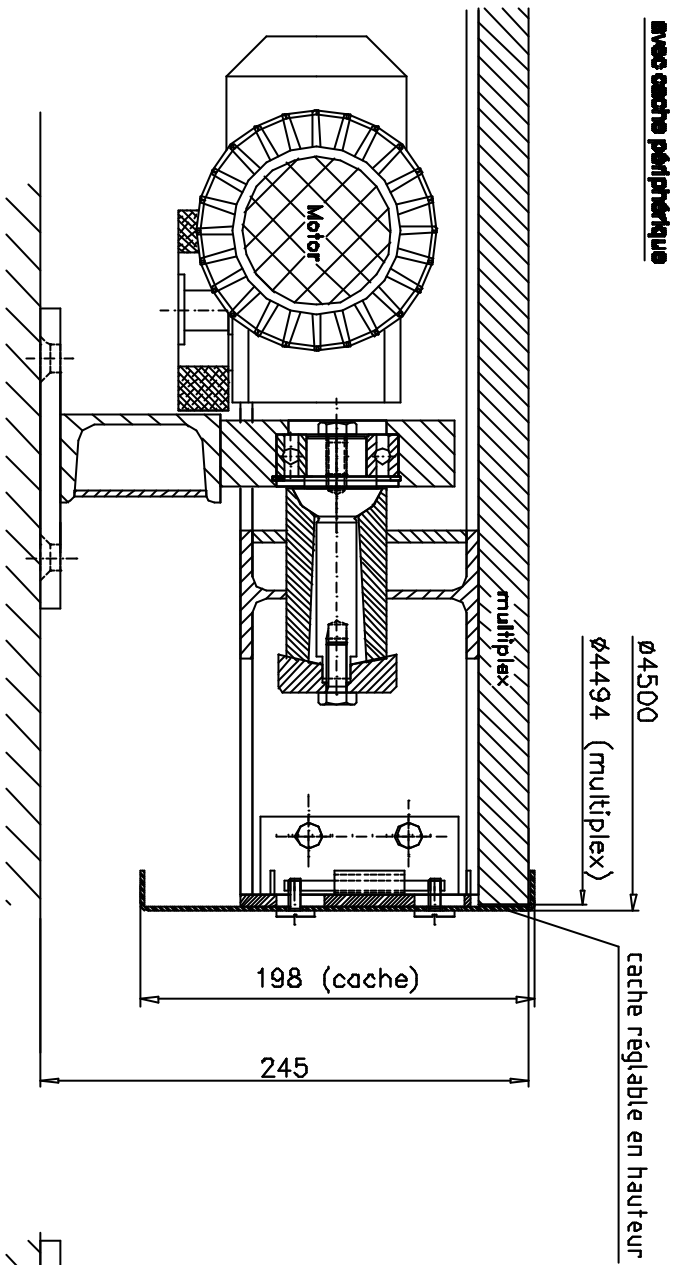

sans cache périphérique

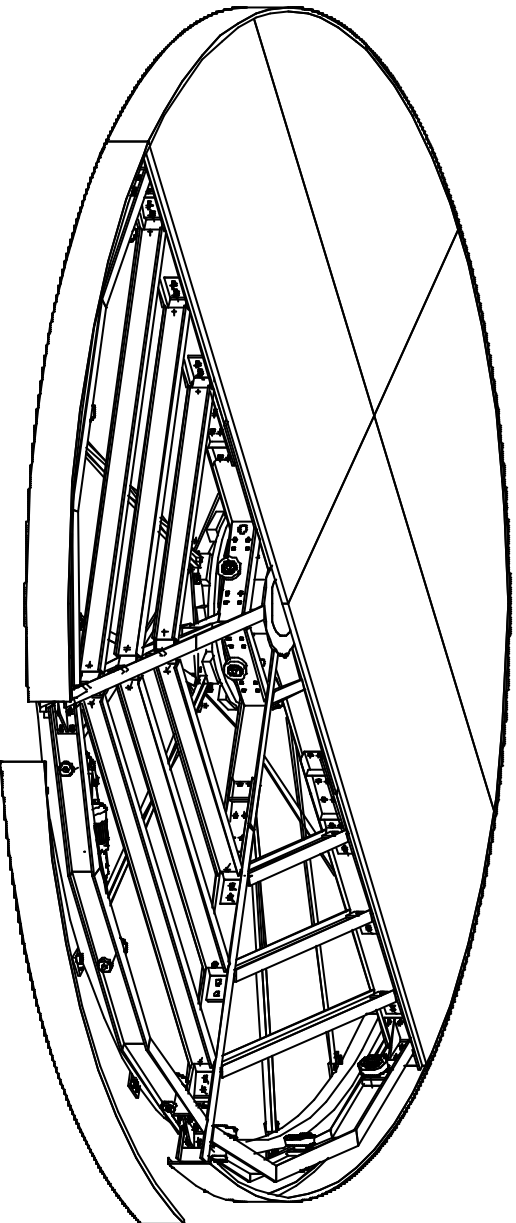
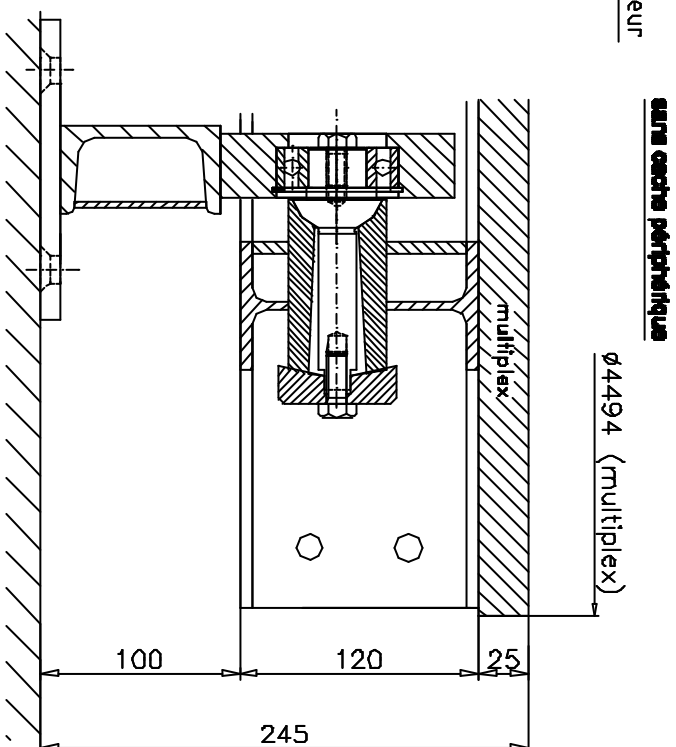

Plateau tournant DSMA 45/40-6

Burnet Bewegungssysteme GmbH
Pflüzer Ring 30
D-66786 Hockenheim

Tel.: +49 (0) 6206 9413-30
Fax: +49 (0) 6206 9413-55
info@burnet.com
www.burnet.com

