

**avec cache périphérique**

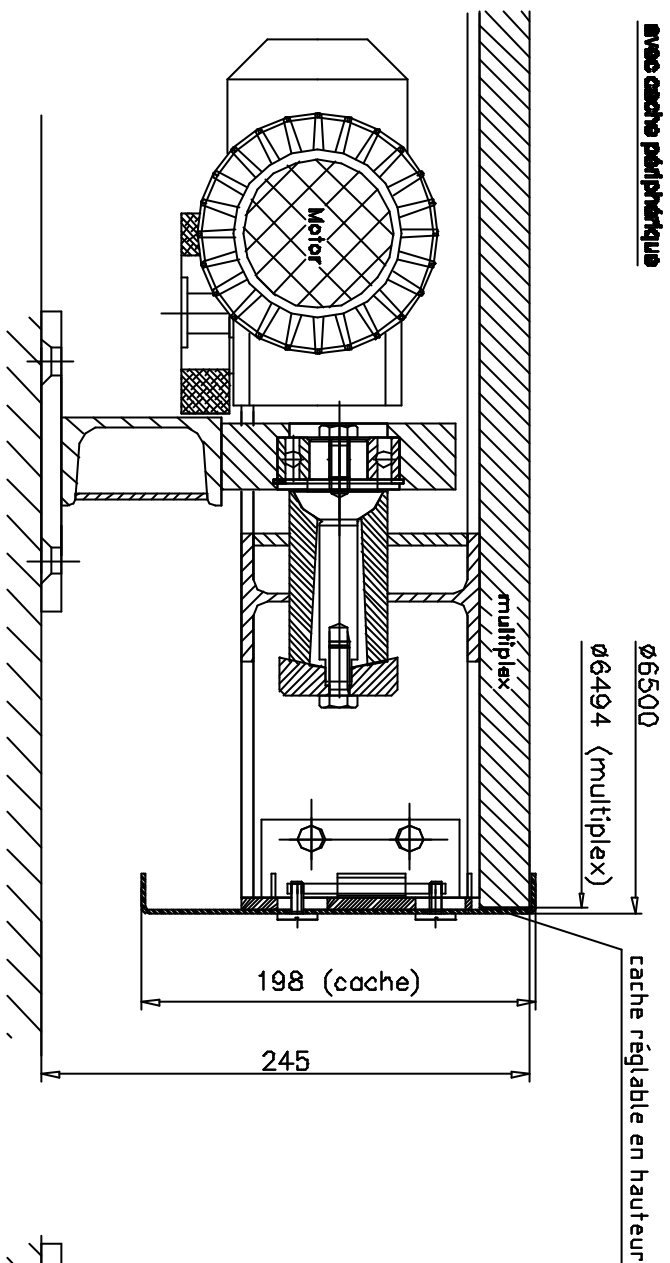

**sans cache périphérique**

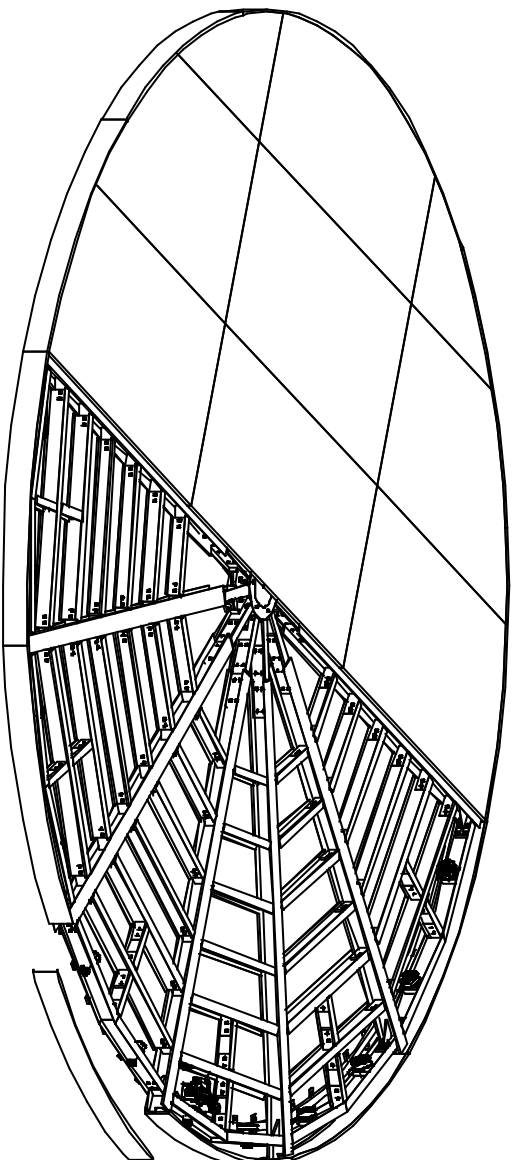
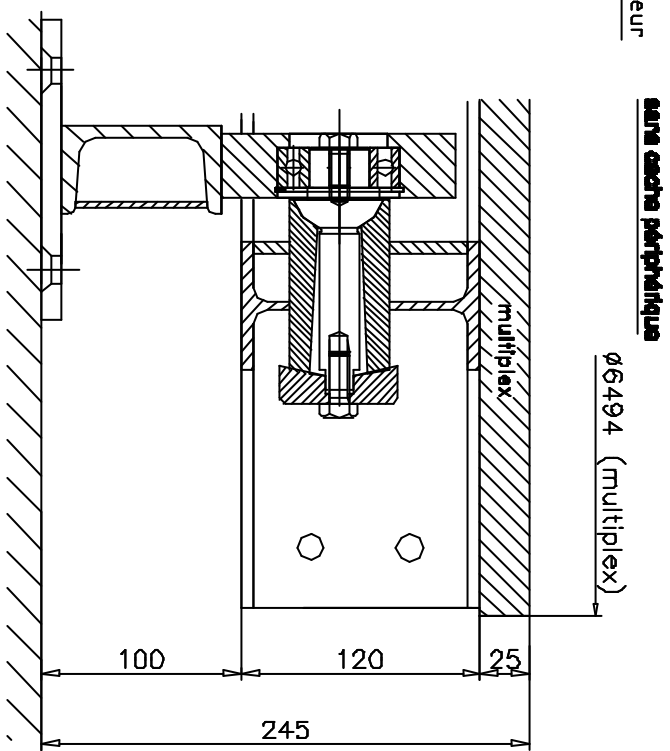

Plateau tournant DSMA 65/60-12

Burnet Bewegungssysteme GmbH  
Pflüzer Ring 30  
D-66766 Hockenheim

Tel.: +49 (0) 6206 9413-30  
Fax: +49 (0) 6206 9413-55  
info@burnet.com  
www.burnet.com

